

TURBONutter

Lada Niva 4x4
Service Manual
Fuel Injection

This manual and a host of other wonderful Lada Niva documentation is available free of charge at:

<http://www.turbo-nutter.com>

You can do anything you like with this manual except sell it or otherwise make money from it.

While I can't stop you sticking it on your own website I would much prefer you linked to its original location on turbo-nutter.com

You use the information contained with this manual at you own risk. If you're not sure how to do something either don't do it or ask someone who knows about such things. The font of all Lada knowledge can be found at:

<http://www.lada.co.uk/forum>

For Lada parts, advice and general all round Lada wonderfulness these blokes aren't bad:

Lada UK Ltd
Askew Rigg
Troutbeck
Penrith, Cumbria
CA11 0SZ
United Kingdom

T: +44 (0) 17 6877 9794
F: +44 (0) 17 6877 9197
E: alan@lada.co.uk
W: <http://www.lada.co.uk>

Lada Parts Australia P/L
42 Aerodrome Road
Caboolture
Queensland
4510
Australia

T: +61 7 5495 5100
F: +61 7 5495 5152
E: andy@ladaparts.com
W: <http://www.ladaparts.com>

Driver s Manual for the Niva 1600 (Vaz 2121 series)



Operator s Manual



This Manual contains a description of the Lada Niva car, description of its' parts, driving tips and specifications. This Manual was scanned from an original Manual supplied with a 1989 Niva 1600. Some details may have changed for subsequent Niva models, notably the Niva 1700 Bushmaster. This Manual complements the Niva Maintenance Manual which I produced in early 1998. This Manual provides information useful for everyday drivers of the Niva such as descriptions of buttons, gauges, switches etc. There is also a good description of the car s appointments for the prospective driver.

The Manual is intended to provide a replacement Manual for owners of Lada Nivas who were not provided with a Manual when purchasing their car. It is not an extra Manual and does not contain any information other than what is contained in the original driver s Manual (except for a few comments I have added and the table of contents). It has been designed to print double sided - hence the arrangements of the wider inner margins.

The Manual contains the following sections:

Introduction

A brief description of the car

Important notices

Information about practices and procedures that must be adhered to, to ensure optimal performance of the car over a long time. Contains do s and dont s of driving a Niva.

Description

This section contains description of parts of the Niva 1600 - (Vaz 2121). Explanations are given of what things are, not necessarily how they work.

Instruments and Controls

Gives a detailed explanation of how to use all of the instruments and controls on the car dashboard, steering wheel and central panel.

Appointments

Explains the use of such things as rear-vision mirrors, ventilation, heating, ash-tray, doors(window-wipers, opening etc), adjusting seats, tail-gate and opening the hood.

Operating instructions

This section provides advice and instructions on how to drive the car - including advice on how to start the engine in particularly cold weather.

' **1989 - 1999.** You may freely print as many copies of this manual for your own use only as you wish provided that you own a Lada Niva. You may not copy, modify, print or in any other way distribute this manual for a profit or cost. *You may not charge any money what-so-ever including: copying, printing, paper or others costs for this manual.* This manual may not be stored on shareware CD-Roms, web-sites other than Galactic Niva or other storage medium. Galactic Niva
(<http://members.tripod.com/~vaz2121/niva/index.htm>).

Support a starving Uni student today!
Send cheques / money / postcards to:

Jason Chapman
3/125 Grange Rd

E-mail: jason_chapman@hotmail.com

Glen Huntly 3163
Victoria, Australia



Table of Contents

INTRODUCTION.....	2	19 swivelling air deflectors.....	16
IMPORTANT NOTICES.....	2	20 air intake port cover control lever.....	16
DESCRIPTION.....	6	21 heater cock control lever.....	16
IDENTIFICATION DATA.....	6	22 heater fan three position switch.....	16
LUBRICATING SYSTEM.....	7	23 back window wiper and washer switch.....	16
FUEL SYSTEM.....	7	24 external lighting switch.....	16
Crankcase breathing system.....	7	25 choke control knob.....	16
Cooling system.....	7	28 coolant temperature gauge.....	17
IGNITION SYSTEM.....	7	29 brake fluid low level warning lamp.....	17
EXHAUST SYSTEM.....	7	30 transfer differential lock warning lamp.....	17
TRANSMISSION.....	8	34 headlight upper beam warning lamp.....	17
Clutch.....	8	35 direction indicator warning lamp.....	17
Gearbox.....	8	36 marker light warning lamp.....	17
Transfer case.....	8	37 trip counter resetting.....	17
Propeller shafts.....	8	38 tachometer.....	17
Front axle.....	8	39 choke warning lamp.....	17
Rear axle.....	8	40 battery no charge warning lamp.....	18
SUSPENSION.....	8	61 parking brake warning lamp.....	18
Front suspension.....	8	43 low oil pressure warning lamp.....	18
Rear suspension.....	8	45 low fuel warning lamp.....	18
STEERING GEAR AND WHEELS.....	8	46 instrument lighting switch.....	18
Steering gear.....	8	49 headlight wiper switch.....	18
Wheels.....	9	50 back window heater switch.....	18
Tyres.....	9	51 cigarette lighter.....	19
BRAKES.....	9	52 rear fog lamp switch.....	19
Service brakes.....	9	53 emergency flasher warning light switch.....	19
Parking brake.....	9	APPOINTMENTS.....	20
ELECTRICAL EQUIPMENT.....	11	Sun visors.....	20
Storage battery.....	11	Rear view mirrors.....	20
Alternator.....	11	VENTILATION AND HEATING.....	20
Voltage regulator.....	11	Windshield Demisting.....	21
Starter.....	11	Heating.....	21
Car radio.....	11	DOORS.....	22
Windshield wiper.....	11	SEATS.....	22
Heater motor.....	11	Engine hood.....	23
Ignition switch.....	11	Installing the number plates.....	23
External lighting and light signalling system.....	11	Fuel tank cap.....	23
Instrument panel.....	11	OPERATING INSTRUCTIONS.....	24
Bulbs.....	11	Starting the engine from cold.....	24
BODY.....	12	Starting from Hot.....	24
Car appointments.....	12	MOVING OFF.....	24
Ventilation and heating.....	12	DRIVING HINTS.....	25
Keys.....	12	Stopping and parking the car.....	25
Air Conditioning.....	12	Running in.....	26
INSTRUMENTS AND CONTROLS.....	13	Seat belts.....	26
1. Headlight switch lever.....	13	Adjusting the spark advance angle.....	27
2. direction indicator switch lever.....	14	Towing the car.....	27
3. Ignition switch.....	14	TABLES.....	29
Anti-theft lock.....	14	BASIC CHARACTERISTICS AND DIMENSIONS.....	29
6 windshield wiper switch lever.....	14	ENGINE.....	31
11. parking brake lever.....	16	FILLING CAPACITIES. LITRES.....	31
15 map shelf.....	16	MAIN ADJUSTMENT AND TEST DATA.....	32

INTRODUCTION

The VAZ2121 is a comfortable, high speed, all wheel drive, cross country, economy car intended to carry passengers and loads on paved roads of any kind and on dirt roads. The car design makes it possible to operate the car at ambient temperatures ranging from plus 45°C down to minus 40 °C.

The advanced design and use of high quality lubricants ensure reliable engine starting at low ambient temperatures down to minus 25°C without a starting pre-heater. If the car is to be operated at ambient temperatures below minus 25°C, it should be kept in a warm garage to ensure reliable starting of the engine. A double circuit brake system incorporating a low brake fluid level warning device and a rear brake pressure regulator comply with the modern safety standards for passenger cars.

High operating properties and dependability, long service life and low labour input in maintenance largely depend upon strict observance of the operating and servicing rules.

The present Manual contains basically a description of the VAZ2121 car, whereas the design features VAZ21212 car are given in a separate chapter.

Inasmuch as the design of the VAZ cars is being constantly perfected, some units and mechanisms may somewhat differ from those described in the present Manual.

IMPORTANT NOTICES

Prior to starting the regular operation of the car the Owner is invited to carefully study the present Manual.

The excellent performance of the car will become more conspicuous and its life will be considerably longer if the Owner strictly adheres to the recommendations laid down below.

The comfortable car is easy to steer and exhibits high spurt and speed capabilities on the road which fact ranks the car with ordinary passenger cars. However, it differs from them in its cross-country ability on slushy dirt roads, sand and snow. Nevertheless, the Owner should always remember that the car is not intended for constant operation under heavy road conditions.

If the car is driven in heavy sections of the road (on mud or sand), wash the car carefully and examine the following parts more frequently than usual:

- Front wheel hub seals and lubricant
- Front brake friction pads;
- Protective rubber boots of the suspension ball supports, steering rod joints, and front wheel drive joints. If the boot is damaged, water and mud penetrate into the joint, causing its abnormal wear and failure. A damaged boot should be immediately replaced with a new one.

After negotiating a deep (0.5 m) ford, check before a trip for water in the power transmission units. Do it by loosening the drain plugs until drops appear. Oil drops indicate that there is no water in the unit.

Do not overload the car in excess of the specified limits. Overloading results in damage of the front suspension elements, bending of the rear axle beam, premature wear of the tyres, vibration of the body end loss of road stability. The mass of the load on the roof luggage carrier (including that of the carrier) should not exceed 50 kg with the payload not exceeding 400 kg.

Elastic suspension of the car absorbs vibrations when driving speedily on bad roads. Sharp jolts, however, may cause deformation of the lower wishbone shafts and damage other parts of the Therefore, when driving roads, do not speed up and avoid striking the curb-stones.

Do not lock the differential at the moment of slipping of both wheels of one of the car driving axles. Lock the differential in advance, taking into consideration the road conditions. Upon negotiating the difficult sections, unlock the differential since **driving along good roads with the differential locked running gear. on such shortens the life of the power transmission mechanisms, and increases the tyre wear and fuel consumption; when braking. the car may go skidding.** The differential locking is in dictated by the warning lamp on the instrument panel.

The engine, gearbox, transfer case, front and rear axles of the Ear should be lubricated only with the oils recommended by the Manufacturer (refer to Appendix 2). The use of oils of other grades will result in premature failure of said units and mechanisms.

The engine is designed to run on gasoline with an octane number not lower than 91. Operation on gasoline with lower octane numbers is not allowed. Red-orange tinted gasoline AN-93 is ethylated. Ethylated gasoline is poisonous, therefore keep it off the hands, skin, clothes and upholstery. Any operations which could result in penetration of ethylated gasoline or its vapours into the mouth are particularly intolerable.

Never use the starter to move the car from rest. Move off only in the 1st gear. If the engine fails to run after three attempts to start it, check the fuel system or ignition system, and eliminate the cause of poor engine starting.

Do not apply the starter with the engine running, since that may lead to breakage of the starter pinion or flywheel teeth.

Never race the engine to the speed bringing the tachometer pointer in the red zone of the scale. If the tachometer pointer is found within the yellow zone, the engine speed approaches the maximum permissible limit (the edge of the red zone).

Bear in mind that exhaust gases are poisonous. Therefore, the premises where the engine is started and warmed up should be properly ventilated.

Do not operate the car with the low engine oil pressure warning lamp glowing. Lighting up of this lamp is permissible at the minimum idling speed. On increasing the engine speed, the lamp must go off. Glowing of the lamp at the engine service speeds indicates

insufficient oil pressure in the engine lubricating system. **Extremely important! Never run the car with the low oil pressure warning lamp on! This will cause rapid engine wear which will cease the engine resulting in total engine destruction!**

Take care of the tyre pressure since driving on under inflated tyres results in their premature wear and impairs car stability and steerability.

When on the move, do not turn the ignition key to position III PARKING (CTORHKA) as it may result in locking the steering shaft by the antitheft device, thus making the car non-steerable. Prior to moving off, check the parking brake lever position; start motion only with the lever all the way down. **While in motion, do not switch off the ignition, since the brake vacuum booster becomes inoperative when the engine is stopped, and the force to be applied to the brake pedal rises considerably.** The car is fitted with highly effective front disc brakes. However, their long service life can be ensured only with due care. Prevent accumulation of dirt in the brake mechanisms, and wash them after driving in deep mud.

If one of the brake circuits fails, braking of the car will be ensured by the other. The trouble, however, results in longer travel of the brake pedal and lower braking efficiency; at the first instant that even may be taken for complete failure of the brakes. Do not release the brake pedal in this case nor depress it repeatedly, since that will only result in lengthening the braking time and distance; instead, press the pedal until the maximum possible braking effect is attained.

With the engine inoperative, never leave the ignition turned on, as this will discharge the storage battery and damage the ignition system units.

To ensure normal functioning of the lighting and signalling systems, make use of the electric bulbs specified in Appendix 1.

To prevent damage to the alternator rectifier, proceed as follows:

- When installing the storage battery on the car, see to it that the wires are connected in compliance with the polarity signs stamped on the wire clamps and battery terminals (the positive terminal is larger than the negative one). The storage battery must be connected to terminal "30" of the alternator only by the positive wire (wire lug marked " + ");
- When the storage battery installed in the car is being slave charged from an external source, be sure that the battery is disconnected from the alternator; do not check the alternator serviceability by short-circuiting its terminal "30" to the ground or to terminal "67" (to check for sparking);
- Do not operate the alternator unless its terminal "30" is connected to the battery.

The car is equipped with an ignition coil that has no series resistor. Therefore, do not short-circuit its terminals to facilitate starting the engine with the starting crank, as it will damage the moving contact spring of the ignition distributor breaker and ruin the ignition switch contact block.

DESCRIPTION

This section contains description of parts of the Niva 1600 - (Vaz 2121). Explanations are given of what things are, not necessarily how they work. See the Instruments and controls section for information on how to operate them - Jason. jason_chapman@hotmail.com

IDENTIFICATION DATA

Identification number of the car is indented on a non-detachable plate secured on the instrument panel (Fig. 1) at the left hand side. The plate is installed to special order.

Model and number of the engine are indented on a boss of the cylinder block located above the oil filter.

Model and number of the body are indented on the upper reinforcement member of the dashboard. The summary nameplate and the plate with international approval signs are secured on the dashboard.

The summary nameplate contains the following data arranged from. top to bottom:

- Abbreviated name of the manufacturing plant;
- The first three letters of the next line are the coded designations of a geographic zone, country and manufacturing plant (X-Europe, T-USSR, A-Volga Automobile Plant);

The following six digits designate the car model;

- The next Latin letter is the coded designation of a year of car manufacture;
- The last seven digits stand for a chassis number (on a car it corresponds to the body number);
- Officially approved gross mass of the car;
- Officially approved gross mass of the car and trailer equipped with brakes;
- Officially approved load on the front axle;
- Officially approved load on the rear axle; engine model and Serial No. of the car.

The plate with international approval signs contains the following data:

Car model;

Sign E states that the car has been tested and it meets the Safety Code Standards worked out by the United Nations European Economic Commission (UNECE);

The digit adjacent to the sign E is a coded designation of the country in which the car has been tested for conformity to the Safety Code Standards (2 France);

The left hand column of the plate contains the numbers of the UNECE Safety Codes while the numbers of the official approval are given in the right hand column.

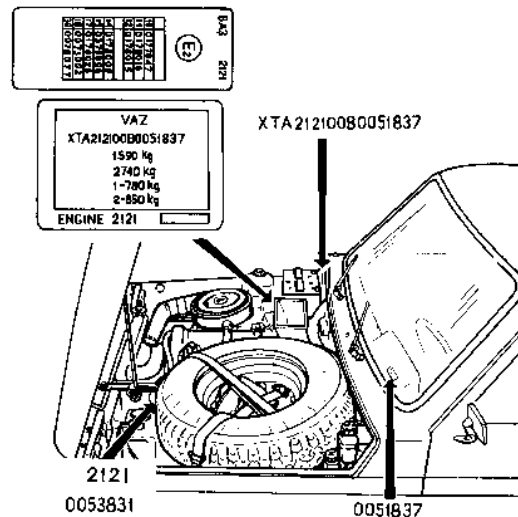

Fig. 1. Identification Data

Lubricating system.

The system is of combination (splash-and-force) type: bearings of crankshaft, camshaft and accessory drive shaft are force-lubricated; cylinders, valve gear and its drive are splash-lubricated, A gear oil pump with an oil intake strainer and a reducing valve in the cover is located in the engine sump. A quick-change full flow oil filter has a filter element made of special cardboard.

Fuel system.

An emulsion type, two barrel, down draft carburettor has a pneumatically controlled secondary throttle, balanced float chamber, crankcase fume recirculation system, pneumatically controlled economiser, diaphragm type acceleration pump, independent idling system and a gauze filter at fuel inlet; the choke is fitted with a diaphragm mechanism for cold engine starting. An air cleaner is fitted with a replaceable element made of special cardboard and a synthetic wool pre-cleaner. An additional oil bath air cleaner is installed to special order. A diaphragm type fuel pump is provided with a gauze filter and a hand priming lever.

Crankcase breathing system.

The system is closed type, with an oil separator and a flame arrester.

Cooling system.

The system is sealed, liquid type with a translucent expansion tank. A solid filled thermostat in a one piece housing is hose connected to the cooling system. A six blade plastic fan fitted on the centrifugal water pump shaft is driven by a V-belt from the crankshaft pulley.

Ignition system.

The system is battery operated, with a rated voltage of 12 V. The ignition distributor is provided with centrifugal and vacuum spark timers driven from the accessory drive shaft. Ignition coil B-117 or B-117A has no series resistor. Spark plugs A17L~B, FE65P and high tension wires with resistors suppressors in the boots or high tension wires FE65CPR with built in resistors suppressors and high tension wires without the resistors suppressors in the boots. The spark plugs have thread MCO M14X1.256E and 19mm reach. The initial spark advance angle is set by marks on the crankshaft pulley and timing gear cover.

Exhaust system.

The system is provided with two successively mounted mufflers, with the tail exhaust pipe at the car rear. To special order the exhaust system is equipped with an exhaust gas recirculation system.

Transmission

Clutch.

The clutch is single plate, dry, with diaphragm pressure spring, and is hydraulically controlled.

Gearbox.

The gearbox is four speed, all forward gears synchro-meshed The gearshift lever is mounted on the floor tunnel.

Gear ratios: 1st gear 3.667; 2nd gear 2.100; 3rd gear 1.361; 4th gear 1.000; Reverse gear 3.526.

Car versions with a five speed gearbox and 5th gear ratio of 0.819 are available.

Transfer case.

The transfer case is of two range type, three shaft, with a centre differential having a positive lock. The differential lock lever and range shift lever are mounted on the floor tunnel.

Gear ratios: High range 1Æ2

Low range 2.135

Propeller shafts.

The intermediate propeller shaft (gear box to transfer case) is provided with an elastic coupling and a needle bearing universal joint. The front and rear axle propeller shafts are provided with needle bearing universal joints at the ends. Each propeller shaft has grease fittings in the splined connections and joints.

Front axle.

The front axle reduction unit with the centre differential is attached to the engine. The final drive is bevel gear, hypoid. gear ratio 4.1. The front wheel drive propeller shafts are provided with oiled for life universal joints.

Rear axle.

The rear axle is a rigid beam. The rear axle reduction unit is provided with a centre differential. The final drive is bevel gear, hypoid, gear ratio 4.1.

Suspension

Front suspension.

Independent, on swinging lateral wishbones, with coil springs, double acting telescopic hydraulic shock absorbers and antiroll bar. The joints need no periodical lubrication.

Rear suspension.

Coil springs, double acting telescopic hydraulic shock absorbers, four longitudinal and one transverse radius rods.

Steering Gear and Wheels

Steering gear.

The steering mechanism including an hourglass worm on ball bearings and a roller on needle or ball bearings is enclosed in an aluminium case. The steering gear ratio is 16.4. The steering linkage side rods are actuated by the pitman arm and centre rod with an idler arm. The steering rod joints need no periodical lubrication. The steering gear is injury safe.

Wheels

Wheels are of drop forged disc type. The rim size is 127-J406 (5J-16). The wheel is fastened with five nuts. The spare wheel is in the engine compartment.

Tyres

are cross-ply 6.9516 (175-406), or radial-ply 175/801116.

Brakes

Used in the car is a two circuit hydraulic brake system.

Service brakes

(combined with emergency brake) Include front disc brakes with movable callipers and three cylinder blocks, and rear aluminium drum brakes with cast iron liners on the working surface, with self aligning shoes and hydraulic cylinders.

The front and rear brakes are hydraulically operated by the foot pedal through master brake cylinder with two coaxial pistons, and a vacuum booster. The rear brake hydraulic circuit incorporates a pressure regulator which reduces the probability of rear wheel locking at braking; in the case of wheel locking, the pressure regulator allows the front wheels to lock earlier which reduces the possibility of skidding. **Note - switching off the engine while in travel deactivates the brake booster pump which in turn makes braking distances greatly longer!**

Parking brake

is hand operated. The rear wheel shoes are cable operated by the lever mounted on the floor tunnel between the front seats.

Notes:

Electrical Equipment

The system is single wire, negative ground return type. Rated voltage is 12 V.

Storage battery

Type 6CT55A, capacity 2 105C (55 A Æh) at 20h discharge rate. The current output at intensive discharge in cold state (minus 18°C) is 255 A.

Alternator

Is an enclosed type machine with a built in rectifier employing silicon diodes; the current output at the engine speed of 5,000 rpm' is 42 A.

Voltage regulator

Is of two stage, vibration type.

Starter

With a solenoid switch and an overrunning clutch. Its power rating is 1.3 kW.

Car radio

"Bylina207" or "Kruis 201" is a stationary set, with an external antenna AP-108 on the front left fender, installed on some of the cars.

Windshield wiper

Is an electrical, two-blade device with two operating modes: continuous and intermittent. Motor power rating is 20 W. Headlight wipers and washers are electrical devices, installed to special order.

Heater motor

Has a power rating of 20 W.

Ignition switch.

The switch controls ignition, external lighting, instrument lighting, and engine starting. It is installed on the steering column and provided with an antitheft device. Horns are electrically operated.

External lighting and light signalling system.

Two headlights with lighting units made to meet European Standards, ride lights combining marker lights and direction indicators, side direction indicators, tail lights combining marker lights, direction indicators, stoplights, backing lamps and reflectors, and rear number plate lamps.

Instrument panel.

Tachometer with parking brake warning lamp, choke warning lamp, and battery no-charge warning lamp; speedometer with odometer and trip counter, and with marker light, direction indicator, and headlight upper beam warning lamps; fuel gauge with low fuel warning lamp; coolant temperature tyre gauge; oil pressure gauge with low engine oil pressure warning lamp; differential lock and brake fluid low level warning lamps.

Bulbs.

See Appendix 1 for places of installation and types.

Body

Body three door, unitized (anodised?), all metal. Its side doors have front mounted hinges and windows provided with two glasses: swivelling vent and roll down. Tailgate (luggage compartment door) opens upwards. The windshield and back window are scenaramic. The triplex windshield and heat tempered back and side glasses are polished and splinter proof. The bumpers are rubber plated at the front and provided with plastic end pieces. The split front seats fitted with headrests are adjustable fore and aft and for rake (or driver's and passenger's comfort. The front seats are hinged to provide access to the back seat which can be folded to increase the luggage compartment area. The seat upholstery is of artificial leather.

Car appointments:

Instrument panel, cigarette lighter, ashtrays in the instrument panel and side walls near the back seat, glove compartment, sun visors, external and internal rear view mirrors, armrests on both doors, seat belts, electric windshield washer, heater, map shelf under the instrument panel on the passenger's side, front end rear wheel splash aprons, and a fire extinguisher holder under the driver's seat. On request, the car may be equipped with an electrically heated back window, rear fog lamp, and back window wiper and washer.

Ventilation and heating.

The heating system is connected to the engine cooling system. Air is distributed by two air deflectors on the instrument panel. The deflectors direct heated air on the windshield or to the upper part of the body interior; heated air is supplied into the lower part of the body interior when the heater cover is open. Air circulation is intensified by an electric fan with two modes of operation. At an ambient temperature of minus 25 °C, an average temperature inside the car is as high as 20 °C with the heating system at full blast; in the area around the driver's and passenger's feet the temperature is about 25 °C. The body interior is ventilated through the holes in the body side panels.

Keys

Each car is furnished with two sets of keys. Each set contains a larger key (Fig. 3) for the ignition switch, and a smaller one for the doors. Each key bears a stamped Series No.

Air Conditioning

The Niva 1600 is not fitted with air conditioning, but it is possible to fit it. This will effect your fuel consumption though. In Australia, you can contact Richmond Auto Electricals on (03) 9428-3185 or (03) 9428 1997 to have air conditioning fitted - Jason



Fig. 3. Car Keys

Notes:

INSTRUMENTS AND CONTROLS

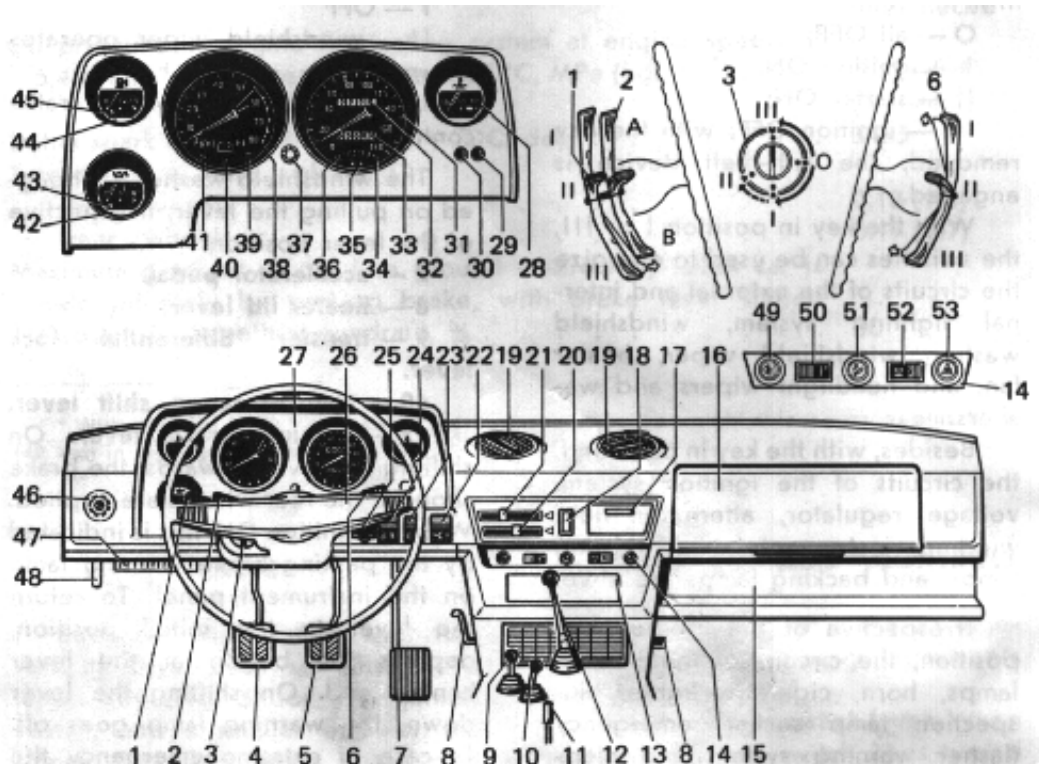

Fig. 4. Instrument and Controls:

1 headlight switch lever; 2 direction indicator switch lever; 3 ignition switch; 4 clutch pedal; 5 brake pedal; 6 windshield wiper switch lever; 7 accelerator pedal; 8 heater lid lever; 9 transfer differential lock lever; 10 transfer range shift lever; 11 parking brake lever; 12 gearshift lever; 13 radio seat decorative cover; 14 dashin panel with additional controls; 15 map shelf; 16 glove compartment; 17 ashtray; 18 plug; 19 _ swivelling air deflectors; 20 air intake port cover control lever; 21 heater cock control lever; 22 heater fan three position switch; 23 back window wiper and washer switch; 24 external lighting switch; 25 choke control knob; 26 horn switch; 27 instrument panel; 28 coolant temperature gauge; 29 brake fluid low level warning lamp; 30 transfer differential lock warning lamp; 31 speedometer; 32 trip counter; 33 odometer; 34 headlight upper beam warning lamp; 35 direction indicator warning lamp; 36 marker light warning lamp; 37 trip counter resetting knob; 38 tachometer; 39 choke warning lamp; 40 battery no charge warning lamp; 41 parking brake warning lamp; 42 oil pressure gauge; 43 _ low oil pressure warning lamp; 44 fuel level gauge; 45 low fuel warning lamp; 46 instrument lighting switch; 47 fuse blocks; 48 hood lock release lever; 49 headlight wiper switch; 50 back window heater switch; 51 cigarette lighter; 52 rear (lasher warning light switch fog lamp switch; 53 emergency flasher warning light switch.

1. Headlight switch lever.

When external lighting switch 24 is turned on and the ignition key is in position I or III, the headlight switch lever may be set in the following positions:

- Position I: headlights OFF
- Position II: lower beam ON
- Position III: upper beam ON

The upper beam of the headlights can also be turned on with the external lighting switch in the OFF position by pulling up the lever along the axis of the steering column. The upper beam of the headlights When released, the lever returns to the initial position automatically.

2. direction indicator switch lever.

When the lever is shifted to position A, the R.H. direction indicators are ON and when it is shifted to position B, the L.H. direction indicators are ON. When the car recovers from a turn the lever automatically returns to the initial position. This can also be done by hand.

3. Ignition switch.

Positions of the ignition key denote the following:

- O all OFF;
- I Ignition ON;
- II starter ON;
- III ignition OFF;

With the key removed, the antitheft device is engaged. With the key in position I or III, the switches can be used to energise the circuits of the external and internal lighting system, windshield washer, windshield wiper, heater fan, and headlight wipers and washers.

Besides, with the key in position I the circuits of the ignition system, voltage regulator, alternator field winding, instruments with warning lamps, and backing lamps are alive.

Irrespective of the ignition key in position I, the circuits of the interior lamps, horn, cigarette lighter, inspection lamp socket, emergency flasher warning system and stop lights are always alive.

Anti-theft lock

To engage the antitheft device when the car is parked, turn the key to position III PARKING and withdraw the key, turn the steering wheel either side until a click is heard which means that the locking bar of the ignition switch has entered the slot on the steering shaft and locked the latter. The antitheft device locks the steering gear when the wheels are in the straight ahead position or turned to the right, or left.

To disengage the antitheft device, insert the key into the ignition switch, and, turning the steering wheel lightly both ways in order to reduce friction arising when the locking bar comes out of the slot, turn the key to position O (OFF).

4 clutch pedal.

5 brake pedal.

6 windshield wiper switch lever.

Positions of the lever:

- I OFF
- II windshield wiper operates intermittently
- III windshield wiper operates continuously.

The windshield washer is engaged on pulling the lever, irrespective of the lever position.

7 accelerator pedal.

8 heater lid lever.

9 transfer differential lock lever.

10 transfer range shift lever.

11. parking brake lever.

On shifting the lever upwards, the brake shoes of the rear wheels are applied. With the ignition ON, this is indicated by the parking brake warning lamp on the instrument panel. To return the lever to the initial position, depress the button at the lever handle end. On shifting the lever down, the warning lamp goes off. **In cases of extreme emergency the parking brake may be applied for slightly braking the car on the move**, or it may be applied concurrently with the service brakes.

12 gearshift lever.**13 radio seat decorative cover.****14 dash in panel with additional controls.****15 map shelf.**

A place for a first aid kit is provided on the shelf.

16 glove compartment.**17 ash tray****18 plug****19 swivelling air deflectors.****20 air intake port cover control lever.****21 heater cock control lever.****22 heater fan three position switch.****23 back window wiper and washer switch.**

The switch is installed instead of the plug, if the car is equipped with a back window wiper and washer. When the lower part of the switch rocker is depressed to the first fixed position, the back window wiper is turned on, and when it is depressed to the second fixed position, the washer (water jet) is additionally turned on. Both are turned off by depressing the upper (riffled) part of the switch rocker as far as it will go.

24 external lighting switch.

When the lower part of the switch locker is depressed, the marker lights come on.

25 choke control knob.

The knob is used for starting the engine from cold. If the knob is pulled all the way out, the carburettor choke is closed, and with the ignition ON, the warning lamp on the instrument panel comes on. If the knob is pushed all the way in, the choke is fully opened (warning lamp is out).

26 horn switch.**27 instrument panel.**

28 coolant temperature gauge.

Passing of the pointer into the red zone of the scale indicates engine over heating. If this is the case, check the alternator drive belt for proper tension, and if the drive belt is tensioned properly, check the cooling system.

29 brake fluid low level warning lamp

(red) It comes on, with the ignition ON, when the level of brake fluid in the reservoir has dropped below the permissible limit due to consumption of fluid or some fault in the brake system.

30 transfer differential lock warning lamp

(amber). It comes on when the ignition is ON and lever 9 is shifted in the differential locking position.

31 speedometer.**32 trip counter.****33 odometer.****34 headlight upper beam warning lamp**

(blue). It comes on when external lighting switch 24 is turned ON and headlight switch lever 1 is in position III.

35 direction indicator warning lamp

(green). It comes on in flashing light when direction indicator switch lever 2 is in the R.H. or L.H. turn position. If one of the direction indicator lamps is defective, the warning lamp will not flicker.

36 marker light warning lamp

(green). It comes on when external lighting switch 24 is turned ON.

37 trip counter resetting

The counter is set to zero, when car is at a halt, by rotating the knob counterclockwise.

38 tachometer

Shows the engine crankshaft speed. The yellow zone of the scale indicates engine operation at a high speed, whereas the red zone indicates dangerous speed range.

39 choke warning lamp

(amber). It comes on if the ignition is ON and the choke control knob is in the pulled out position.

40 battery no charge warning lamp

(red). It comes on when the ignition is turned ON; the lamp goes off immediately on starting the engine. If the lamp stays ON with the engine running, the alternator drive belt is slack or the alternator is faulty.

From experience this is most often caused by a worn fan belt. **Replace the fan belt immediately or you risk burning out the alternator!** - Jason

61 parking brake warning lamp

(red). If the ignition is ON, the lamp comes on in flashing light after the brake lever is shifted to the upper position.

42 oil pressure gauge.**43 low oil pressure warning lamp**

(red). The lamp comes on when the ignition is ON. The lamp must go off when the speed of the started engine is above the minimum rpm.

Extremely important! Never run the car with the low oil pressure warning lamp on! This will cause rapid engine wear which will cease the engine resulting in total engine destruction!

Make sure you are always topped up on oil!

44 fuel level gauge.**45 low fuel warning lamp**

(red). It comes on when less than 4-6.5 litres of fuel remains in the tank.

46 instrument lighting switch.

It is energised when external lighting switch 24 is turned ON. Instrument lighting is turned on and its brightness is regulated by turning the switch knob.

47 fuse blocks**48 hood lock release lever.****49 headlight wiper switch.**

The headlight wipers and washer are turned ON by depressing the switch button, if the headlight lower beam is ON. When released, the button automatically returns to the initial position.

50 back window heater switch

This is installed instead of the plug if the car is equipped with a back window heater. When the rocker ruffled portion is depressed to the fixed position, the back window heater is turned ON and the warning lamp with an orange lens in the switch comes on.

51 cigarette lighter.

To use the lighter, depress and release immediately the holder button which remains depressed for approximately 15 s. Then the button automatically returns to the initial position and the lighter is ready for use. With the instrument lighting ON, a special lamp illuminates the lighter socket.

52 rear fog lamp switch

Is in stalled instead of the plug if the car is equipped with a rear fog lamp. The lamp is turned on by depressing the left part of the switch rocker. The warning lamp with an orange lens in the switch proper comes ON in this case.

53 emergency flasher warning light switch.

Pressing on the button results in flashing of all direction indicators and of a warning lamp in the button proper. The emergency flasher warning lights are switched off by pressing on the button for the second time.

Notes:

APPOINTMENTS

Sun visors

Are intended to protect the driver and passenger from the dazzling sun. In case of head on rays, set the visor (Fig. 5) in position I, in case of side rays, in position II.

Rear view mirrors

Internal rear-view mirror (Fig. 6) ensures observation of the road behind the car. If the driver is dazzled by the headlights of a vehicle following behind, use the lever to change the mirror tilt.

External rear-view mirrors serve for observing the road behind the car, particularly when the dimensions of the load carried in the luggage compartment of the car obstruct observation of the road by means of the internal rear-view mirror, or when the back window is covered with mist.

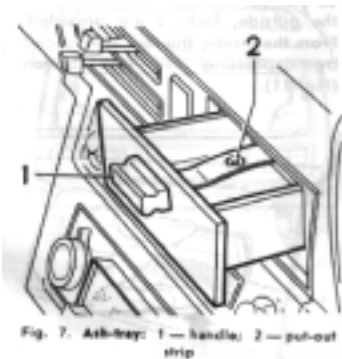

Ashtray

To open the ashtray, pull handle 1 (Fig. 7). To empty, depress cigarette put out strip 2, and remove the ashtray.

Headrests

are mounted on the front seats. Adjustable in height, the headrests are held in the required position by spring detents. Inspection lamp socket is located in the engine compartment on the bracket of the hydraulic brake fluid reservoir.

Ventilation and heating

Depending on the temperature of outside air, ventilation and heating of the car can be adjusted as described below.

The outside air can enter the car body as follows:

- through the open swivelling vent windows; to open, depress button 1 (Fig. 8), and turn handle 2;
- through the window if the roll-down glasses are lowered by rotating handle 3;
- through air deflectors 1 (Fig. 9) when lower lever 4

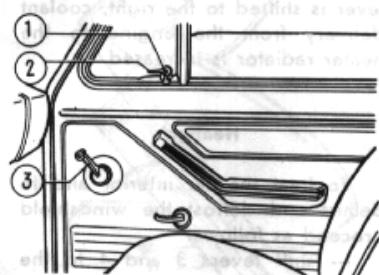
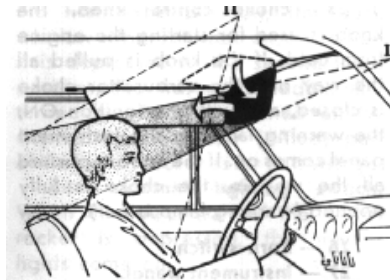

controlling the air intake port cover is shifted to the right. Shifting the lever right wards increases the supply of the outside air through the heater radiator; through the heater grille if the lid is opened by means of lever 5, with lower lever 4 shifted to the right. Turning of the deflectors changes the direction of the air flow. If the car moves at a low speed, the amount of supplied air can be increased by cutting in the heater fan with switch 2. The fan is driven at the lower speed on depressing the lower part of the switch rocker to the first fixed position, and at the higher speed on depressing the rocker to the second fixed position. The fan is switched off by depressing the upper part of the switch rocker as far as it will go.

Windshield Demisting

To demist the windshield it is enough to blow cold air on it. For this purpose, shift lower lever 4 to the right and, having closed the heater lid with lever 5 turn air deflectors 1 so that the air stream is spread over the greater area of the windshield. To warm slightly the supplied air, shift upper lever 3 part way to the right. When the lever is shifted to the right, coolant delivery from the engine to the heater radiator is increased.

Heating

To heat the car interior and to demist and defrost the windshield proceed as follows:

shift levers 3 and 4 to the right;



Fig. 9. Heating System Controls:
1 swivelling air deflectors; 2
heater fan three position switch;
3 heater cock control lever; 4 air
intake port cover control lever; 5
heater lid levers

if necessary, cut in the heater fan with switch 2;
 open the heater lid with lever 5. Hot air will be directed to the driver’s and passengers’ feet zone, as well as onto the windshield. To speed up warming of the windshield, close the heater lid. If the ambient air temperature is very low, shift lever 4 part way to the right so as to limit the inflow of cold air.

Doors

To open the side doors, press the door handle upwards (Fig. 10). As soon as the door is opened, the interior lamps come on automatically. For locking the doors from the outside, locks 1 are provided. From the inside, the lock is engaged by depressing the lock button (fig 11)

Do not press the button when the door is open, since in this case the inside locking mechanism is inoperative. (ie, there s no point trying to open an already open door)

To open the door from the inside pull handle 1, irrespective of the position of the locking button.

To open the luggage compartment tailgate, unlock it with the side door key and depress lock button 1 (Fig. 12). In the open position, the tailgate is retained by gas filled telescopic props.

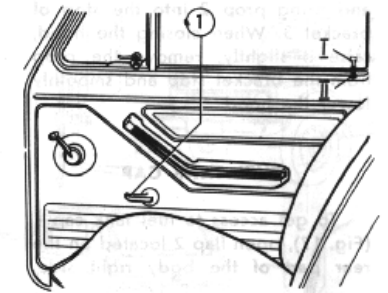
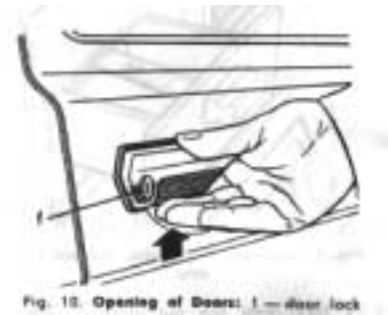
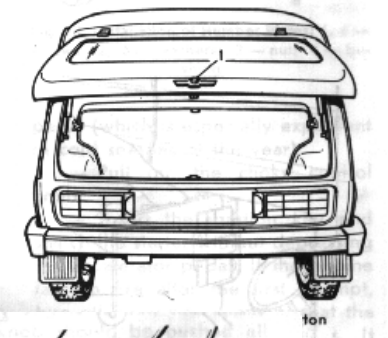

Fig. 11. Side Door: I lock released; II lock engaged; I door handle



Seats

For fore and aft adjustment of the front seats, turn down lock handle 1 (Fig. 13). Release the handle after the seat is shifted to the desired position and slightly move it to and fro to make sure it is fixed reliably. To tilt the seat backrest slightly, rotate knob 2. To incline the seat backrest through a larger angle, raise knob 2, adjust the seat backrest to a desired rake, and release the knob.

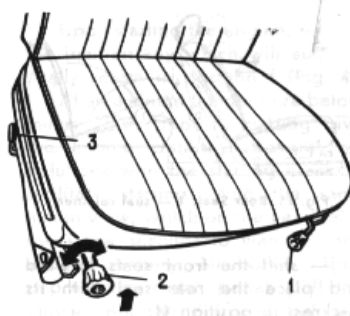

Fig. 13. Front Set: (lock handle; 2 back rake adjusting knob; 3 handle

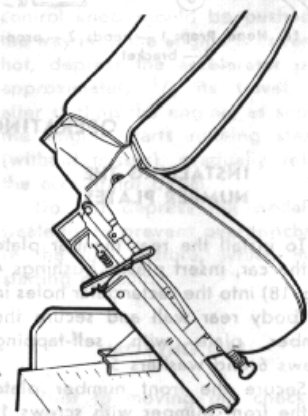

Fig. 14. Front Seat Tilt

To make berths in the car, remove the headrests, shift the seats to the foremost position, and throw back the seat backrests, setting them in plane with the back seat.

To provide access to the back seat, depress handle 3 and tilt the front seat as shown in Fig. 14.

The back seat is folding. To enlarge the luggage

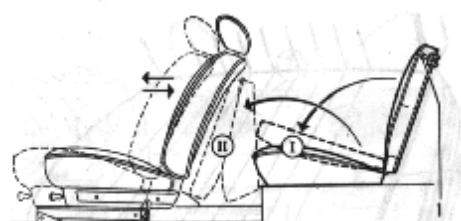

Fig. 15. Rear Seat: 1 — seat retainer

compartment area proceed as follows: press off seat retainers 1 shift the front seats forward and place the rear seat with its backrest in position II; shift the front seats rearward and make their positions convenient.

Engine hood

To open the engine hood, pull lever 48 (Fig. 4), raise hood 1 (Fig. 16) and bring prop 2 into the stop of bracket 3. When closing the hood raise it slightly, remove the prop from the bracket stop and smoothly lower the hood.

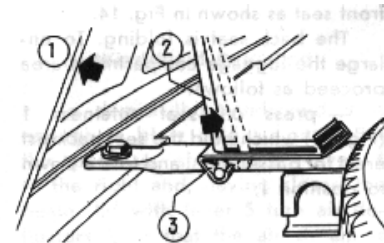

Fig. 16. Hood Prop: 1 — hood; 2 — prop; 3 — bracket

Note: In windy weather the hood may blow close. You can usually prevent this by jamming a screwdriver provided in the tool kit into the groove which the prop rests in. - Jason

Installing the number plates

To install the rear number plate on the car, insert plastic bushings 4 (Fig. 18) into the rectangular holes in the body rear wall and secure the number plate with self tapping screws 6 and washers 5. Secure the front number plate on the front bumper with screws 1, nuts 3 and washers 2.

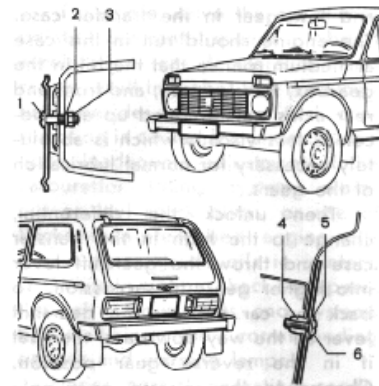

Fig. 18. Installation of Number Plates: 1, 6 — screws; 2, 5 — washers; 3 — nut; 4 — bushing

Fuel tank cap

To get access to fuel tank cap 1 open flap 2 located on the rear part of the body right side behind the side doors.

OPERATING INSTRUCTIONS

Starting the engine from cold

Pump some fuel into the carburettor float chamber by operating hand priming lever 1 (Fig. 19) several times. It is advisable to perform the above operation after a long standstill of the car.

Set the gearshift lever in the neutral and depress the clutch pedal (which is especially expedient in cold seasons of the year).

Pull out the choke control knob.

Insert the ignition key and switch the starter without depressing the accelerator pedal. If the engine fails to fire after the first attempt, turn off the ignition, and repeat the starting in approximately 30 s. It is not recommended to operate the starter for longer than 10 s.

Upon starting the engine, release the ignition key which will automatically return in position I (Fig. 4).

At an ambient temperature below minus 25°C prior to starting give the engine crankshaft several revolutions with the starting crank to facilitate starting. With the same aim in view, switch on the headlights for a few seconds to warm up the storage battery electrolyte. Then depress the clutch pedal, pull the choke knob all the way out and switch on the starter. In case of steady running of the engine after starting, smoothly release the clutch pedal, and, as the engine speeds up, gradually push back the choke control knob.

At an ambient temperature below minus 25 °C and during heavy snow falls, it is recommended to put on a winterizing cover on the radiator grille in order to intensify engine warm-up and maintain its thermal conditions.

Starting from Hot

If the engine is hot, the choke control knob should be pushed all the way in. If the engine is extremely hot, depress the accelerator pedal approximately one third its travel, end after starting the engine, as soon as the engine starts running steadily (without misses), gradually release the accelerator pedal. Do not depress the pedal repeatedly to prevent over enrichment of the fuel mixture, which makes starting difficult.

MOVING OFF

Prior to moving off, check the position of the transfer levers; the range shift lever must be in the HIGH position (Fig. 20), and the differential lock lever must be in UNLOCKED position. To move off proceed as follows: depress the clutch pedal all the way down and throw the gearshift lever into the 1st gear (Fig. 21); release completely the parking brake lever; release the clutch pedal slowly, and gradually depress the accelerator pedal. At very low ambient temperatures and after a long standstill, it is good practice to drive at least 1 Km in the 1St gear with the differential locked and low gear in the transfer case. The engine should run in this case at medium rpm so that the oil in the gearbox, transfer case, and front

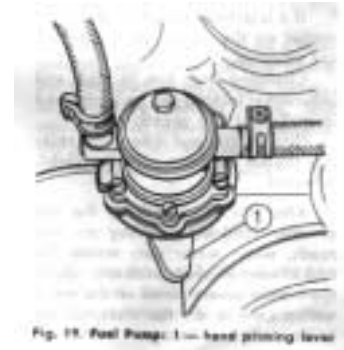

Fig. 19. Fuel pump: 1 — hand priming lever

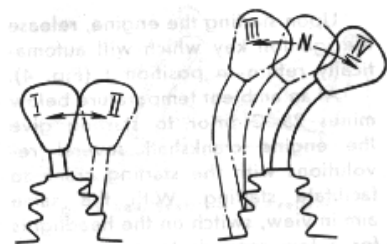

Fig. 20. Transfer Case Levers: Positions of differential lock lever: I — unlocked; II — locked. Positions of range shift lever: III — low; N — neutral; IV — high

and rear axles gets warmed up and be comes less viscous which is absolutely necessary for normal lubrication of the gears.

Then unlock the differential, change to the high in the transfer case and throw the gearshift lever into higher gears in succession. To back the car depress the gearshift lever all the way down and then set it in the reverse gear position. Change to the reverse gear only when the car has come to a complete stop

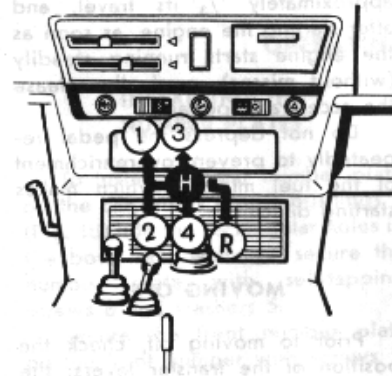

Fig. 21. Gearshift Lever

Driving hints

This rather amazing section actually tells you how to drive a Niva! - Jason

To negotiate steep upgrades and loose ground and to move at a mini mum stable speed on hard surface roads, change to the low range in the transfer case in advance. Do that only after bringing the car to a complete stop. To negotiate difficult sections of the road, lock the differential; unlock it upon negotiating such sections of the road. If it is difficult to unlock the differential on the move, do it with the car stopped. Changing from low to high and differential locking can be performed in motion at any speed. Gear shifting and differential locking should be done with the clutch released.

After fording, washing the car or after long time driving on wet roads, when water gets inside the brake mechanisms, smoothly apply the brakes several times on the move with a view to dry the discs, drums, brake pads and linings.

If possible, drive the car at moderate constant speeds. Abrupt acceleration or deceleration and racing result in higher fuel consumption. Besides, excessive fuel consumption is caused by: under-inflated tyres, inadequate adjustment of the carburettor idling system, worn out or foul spark plugs, or use of thicker than prescribed engine oils (i.e. summer grade oils in winter). While in motion, check the operation of various units and systems by watching the corresponding gauges and warning lamps. Under normal operating conditions all red warning lamps must be out; lighting of a lamp calls for checking the respective system.

Stopping and parking the car

To stop the car remove the foot from the accelerator pedal, depress the clutch pedal all the way down, throw the gearshift lever into the neutral, and depress the brake pedal. The design of the car brakes ensures efficient braking. Nevertheless, apply the brakes smoothly and gently in all instances, avoiding abrupt braking.

When parking the car on a level ground, apply the parking brake, but when parking on a slope, besides applying the parking brake, shift into the 1St or reverse gear, depending on whether the car is parked on an upgrade or a downgrade.

Running in

During the first 2.0003.000 Km:

1. Check the tyre inflation pressure and bring it to normal before each trip.
2. While in motion, and in the warm-up time after starting the engine (especially after starting from cold) do not rev up the engine in excess of 4,000 rpm
3. Do not take heavy roads (deep mud or snow, sand and steep upgrades).
4. Avoid towing a trailer.
5. Timely shift into a lower gear in compliance with the road conditions, trying to avoid engine over loading.
6. Do not change the engine oil filled at the Manufacturer's. For better running-in, the crankcase is filled with winter grade oil. Therefore, during the running-in in a hot season the oil pressure may be somewhat lower than the rated value of 0.35 MPa (3.5 kgf/cm²), which fact should not be considered as a symptom of trouble of the lubricating system. Bear in mind that high reliability and long service life of all units and mechanisms of the car largely depend on operation of the car during the running-in period.

Seat belts

The seat belts are an effective means of protecting the driver and passengers against grave consequences of traffic accidents. The cars are equipped with the belts of two types: with inertia reels and without the reels. In the first case the belts need no adjustment in length, while in the second case adjustment is necessary. The length of the belt should be adjusted so that a palm is free to pass between the breast and diagonal strap 2 (Fig. 22), while waist strap 4 tightly fits the hips. The length is set by length adjuster 3.

To fasten the belt, insert tongue 5 into lock 7 until a click is heard. Prevent twisting of the straps. Do not strap down a child sitting on the passenger's lap.

To unfasten the belt, press button 6 of the lock. After unfastening the belts without inertia reels insert tongue 5 into the pocket of cover plate 1.

In case of fouling clean the straps with a soft soap solution. Never iron the belts.

If the belt has been subjected to a critical load in a traffic accident, or is chafed, ruptured or otherwise damaged, it must be replaced with a new one.

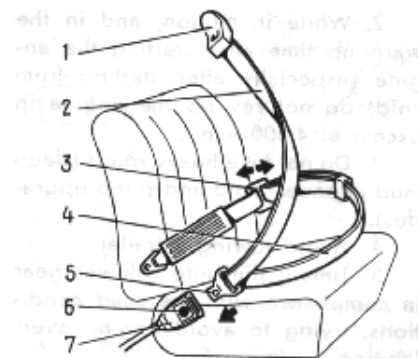

Fig. 22. Seat Belt: 1 — cover plate; 2 — diagonal strap; 3 — length adjuster; 4 — waist strap; 5 — tongue; 6 — button; 7 — lock

Adjusting the spark advance angle

While in service, sometimes it becomes necessary to adjust the spark advance angle in order to suit the quality of the fuel used.

Perform adjustment on a warmed up engine. Driving the car in the high gear on a level road at a speed of 50 km/h, abruptly depress the accelerator pedal. If this is accompanied by slight and short time detonation, the spark advance angle is set correctly. In case of heavy detonation (early ignition), note the position of the middle mark of scale 3 (Fig. 23) on the cylinder block, loosen nut 1 and turn body 2 through 0.51 division clockwise (towards the + sign).

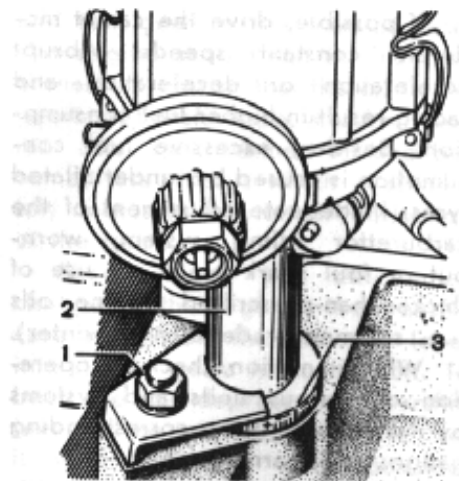

Fig. 23. Adjustment of Spark Advance Angle:
1 — nut; 2 — body; 3 — scale

In case there is no detonation (late ignition), turn body 2 through 0.51 division counterclockwise (towards the "+" sign).

Adjustments over, tighten nut 1 and repeat checking the spark advance angle on the move.

Towing the car

For towing attach the towing cable only to front towing lugs 1 (Fig. 24) or rear towing lugs 2 provided for the purpose. Tow the car smoothly, without jerks or sharp turns.

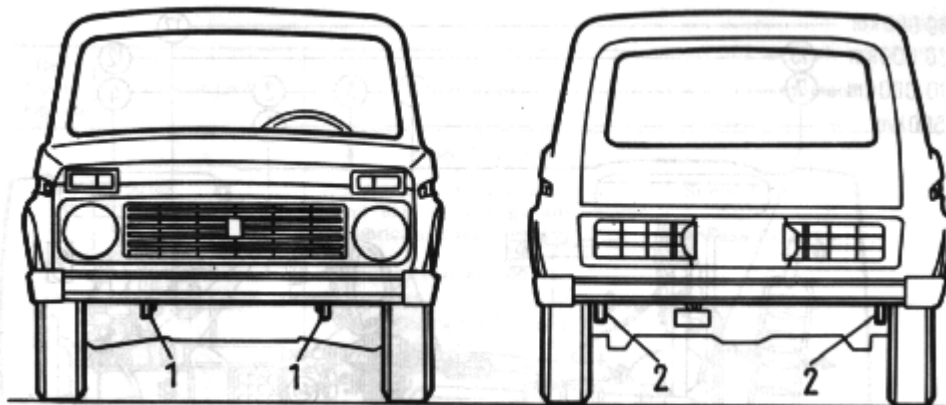

Fig. 24. Towing Lugs: 1 — front lugs; 2 — rear lugs

Notes:

Tables

Basic Characteristics and Dimensions

Seating capacity, Persons	4 or 5
Seating capacity with back seat folded, persons	2
Payload, kg	400
luggage allowed, Kg Maximum	
with 4 person	120
with 2 Persons	260
with driver only	330
Dry mass (mass of car less fuel, oil, coolant and accessories), kg	1,070
Kerb mass. (mass of car in running order less payload). Kg	1,150
Gross mass, kg	1,550
Mass of front axle, kg	
kerb	680
gross	750
Mass on rear axle, kg	470
Overall dimensions (at 322 mm static tyre radius), mm	See Fig. 2
Minimum road clearance, loaded, at 322 mm static tyre radius, mm:	
to front suspension cross member	228
to rear axle beam	220
to engine oil sump	319
Minimum outer turning radius over from bumper extremity, m	5.8
Minimum outer turning radius over front wheel track axis: m	5.5
Maximum speed ***, km/h	
-fully loaded	130
-with driver and passenger only	132
Acceleration time *** from rest to 100 km/h through gears, s:	25
Maximum fuel consumption*** per 100 Km in summer, fully loaded,	
L (not over):	
at 90 km/h in 4th gear	10.5
under city traffic conditions	13.4
Maximum gradeability, %	58
Maximum braking distance, fully loaded, at 80 km/h on level section of dry, straight asphalt road, m: (presumes good tyres)	
service braking	40
emergency braking (ons circuit of service brakes)	90

*For Short Trips

**With 330kg luggage carried, 70 kg of it should be placed on the front seat, and the remaining 260 kg should be uniformly distributed over the entire luggage compartment floor.

*** As measured by applying special technique.

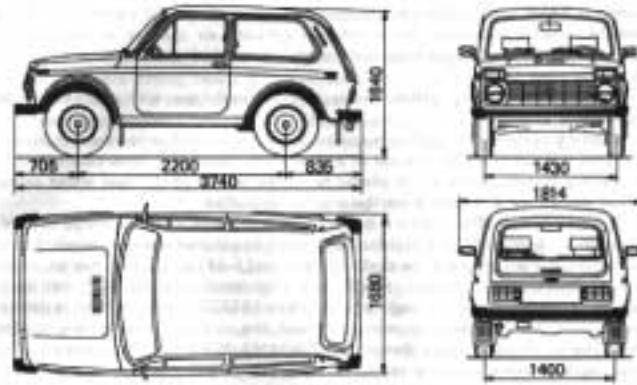

Fig. 2. Overall Dimensions

Engine

Model	VAZ2121
Type	four-stroke carburettor
Number and arrangement of cylinders	four, in-line
Cylinder bore and piston stroke, mm	79x80
Engine displacement, L	1,568
Compression rate	8.5
Rated power	
ISO 1585-82, at 5,400 rpm', kW (hp), minimum	53.7 (73.0)
Maximum torque, ISO 158582, at 3,400 rpm', N m (kgfÆ m	114(11.6)
Minimum idling speed, rpm	850-900
Firing order	1-3-4-2
Sense of crankshaft rotation	clockwise
Maximum carbon monoxide (CO) content in exhaust gases at idling, %	1.5

Filling Capacities. Litres

Fuel tank (including reserve of 4-6.5 L)	42
Engine cooling system (including interior heating system)	10.7
Engine lubricating system (including oil filter)	3.75
Gearbox	1.35
Rear axle housing	1.3
Steering gear case	0.215
Transfer case	0.75
Front axle housing	1.15
Clutch hydraulic control system	0.2
Hydraulic brake system	0.66
Front shock absorber	0.12
Rear shock absorber	0.195
Windshield washer reservoir	2.0
Back window washer reservoir	2.0
Additional air cleaner	0.45

This image does not appear in the original Niva manual. Many thanks to the Royal Auto Club of Victoria (Australia)

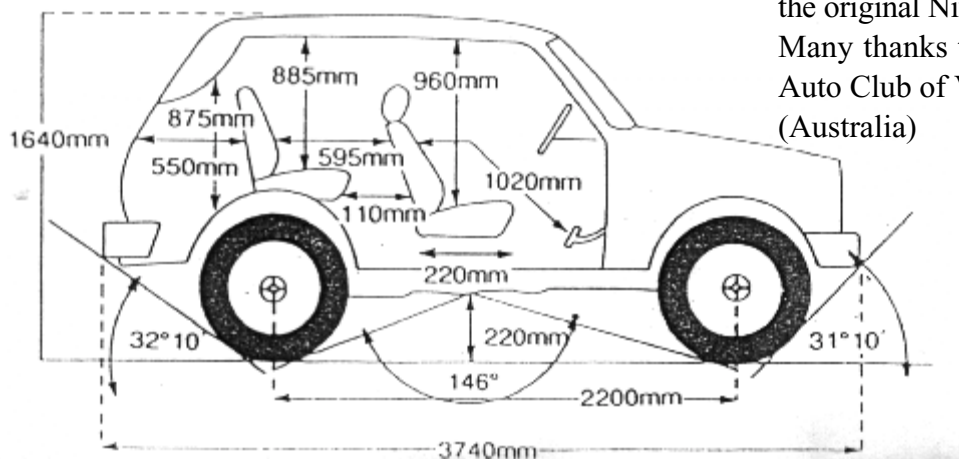

Main Adjustment and Test Data

Valve rocker to cam clearances (engine cold), mm	0.15
Breaker point gap, mm	0.4 +/- 0.05
End play in front wheel hub bearings, mm	
set during adjustments	0.01-0.07
maximum permissible in service	0.15
Fan belt deflection under 100 N (10 kgf), mm	10-15
Spark plug gap, mm	0.5-0.6
Clutch pedal free travel, mm	25-35
coolant specific gravity at 20.C, g/cm	1.078-1.085
Brake pedal free travel (engine shut down), mm	3-5
Maximum steering wheel play (car wheels in straight ahead position)	5°
Same, measured on wheel rim, mm	18-20
Toe in for run-in laden car *, measured between wheel rims, mm	2-4
Camber for run in laden car *, measured between wheel rim and vertical, mm	1-5
Degrees	0°30 +/- 20
Caster for run in laden car *	3°30 +/- 30
Kingpin inclination for run in car *	11°30
Minimum permissible thickness of brake pads and linings, mm:	
front brakes	1.5
rear brakes	2
Maximum temperature of coolant in warmed up engine at ambient temperature of 20-30°C with fully laden car running at 80 km/h, ° C	95
Coolant level in expansion tank (cold engine) above MIN mark. cm.	3-4
Fluid level in brake and clutch reservoirs	to lower edge of filler necks
Oil pressure in engine lubricating system at engine speed of 5,400 rpm and oil temperature of 85 °C, MPa (kgf/cm ²)	0.35-0.45 (3.5-4.5)
Initial spark advance angle before TDC, deg	3-5
Tyre pressure, MPa (kgf/cm ²):	
front wheels	0.18(1.8)
rear wheels	0.17(1.7)
Maximum gradient of dry firm ground where fully laden car is held infinitely by parking brake, with brake lever shifted through 45 teeth of quadrant, %	30

*With a load of 3,200 N (320 kgf) which corresponds to the weight of four perrons plus 400 N (40 kgf) in luggage compartment.